

Перфорированные кабельные лотки предварительной оцинковки (PG)

Наименование		A:	e:	Ед.	h:	L: (мм)	Вес
1	TSTK-A10, TSTK-B10, TSTK-C10 PG, Перфорированный кабельный Лоток	100 мм	0,7	метр	50	3000	1,225
					60	3000	1,470
			0,8	метр	50	3000	1,400
					60	3000	1,680
					100	3000	2,040
			1	метр	50	3000	1,750
		60			3000	2,100	
		100			3000	2,550	
		2	TSTK-A20, TSTK-B20, TSTK-C20 PG, Перфорированный кабельный Лоток	200 мм	0,8	метр	50
60	3000						2,448
100	3000						2,640
1	метр				50	3000	2,550
					60	3000	3,060
					100	3000	3,300
1,2	метр			50	3000	3,060	
				60	3000	3,672	
				100	3000	3,960	
3	TSTK-A30, TSTK-B30, TSTK-C30 PG, Перфорированный кабельный Лоток	300 мм	0,8	метр	50	3000	2,680
					60	3000	3,216
					100	3000	3,280
			1	метр	50	3000	3,350
					60	3000	4,020
					100	3000	4,100
		1,2	метр	50	3000	4,020	
				60	3000	4,824	
				100	3000	4,920	
4	TSTK-A40, TSTK-B40, TSTK-C40 PG, Перфорированный кабельный Лоток	400 мм	1	метр	50	3000	4,150
					60	3000	4,773
					100	3000	4,900
			1,2	метр	50	3000	4,980
					60	3000	5,727
					100	3000	5,880
			1,5	метр	50	3000	6,250
					60	3000	7,188
					100	3000	7,350
			2	метр	50	3000	8,300
					60	3000	9,545
					100	3000	9,800

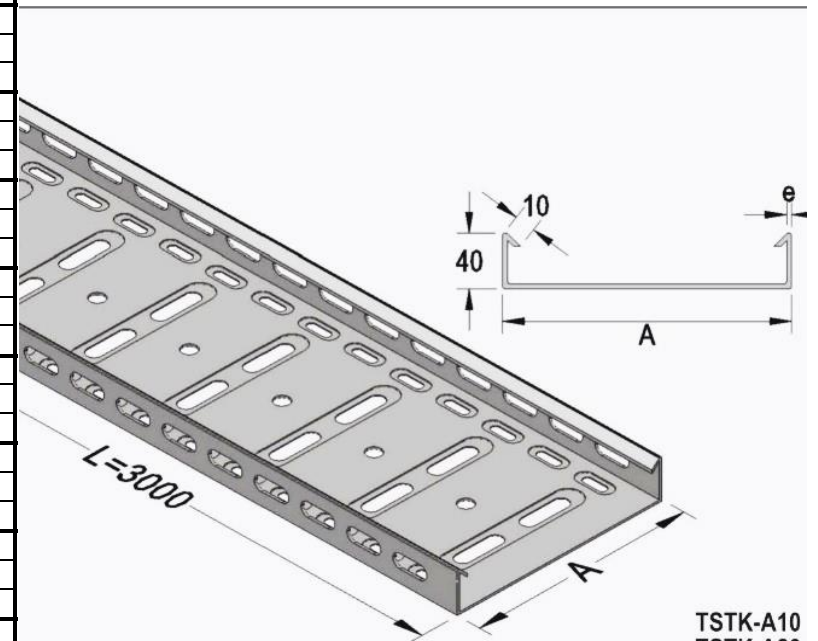

TSTK-A10
TSTK-A20
TSTK-A30

5	TSTK-A50, TSTK-B50, TSTK-C50 PG, Перфорированный кабельный Лоток	500 мм	1	метр	50	3000	4,950
					60	3000	5,445
					100	3000	5,700
			1,2	метр	50	3000	5,940
					60	3000	6,534
					100	3000	6,840
			1,5	метр	50	3000	7,450
					60	3000	8,195
					100	3000	8,500
			2	метр	50	3000	9,900
					60	3000	10,890
					100	3000	11,400

Усиленные перфорированные кабельные лотки предварительной оцинковки (PG)							
Наименование		A:	e:	Ед.	h:	L: (мм)	Вес
6	TSKT-A5 PG, TSTK-B5 PG, Перфорированный кабельный Лоток	50 мм	0,7	метр	50	3000	0,868
					60	3000	1,042
			0,8	метр	50	3000	0,992
					60	3000	1,190
			1	метр	50	3000	1,240
					60	3000	1,488
7	TSKT-A10 PG, TSTK-B10, TSTK-C10 PG, Перфорированный кабельный Лоток	100 мм	0,7	метр	50	3000	1,225
					60	3000	1,470
			0,8	метр	50	3000	1,400
					60	3000	1,680
					100	3000	2,040
			1	метр	50	3000	1,750
					60	3000	2,100
					100	3000	2,550
8	TSKT-A20 PG, TSTK-B20, TSTK-C20 PG, Перфорированный кабельный Лоток	200 мм	0,8	метр	50	3000	2,040
					60	3000	2,448
					100	3000	2,640
			1	метр	50	3000	2,550
					60	3000	3,060
					100	3000	3,300
			1,2	метр	50	3000	3,060
					60	3000	3,672
					100	3000	3,960
					50	3000	2,680



9	TSKT-A30 PG, TSTK-B30, TSTK-C30 PG, Перфорированный кабельный Лоток	300 мм	0,8	метр	60	3000	3,216
					100	3000	3,280
					1	метр	50
			60	3000	4,020		
			100	3000	4,100		
			1,2	метр	50	3000	4,020
					60	3000	4,824
					100	3000	4,920
			10	TSKT-A40 PG, TSTK-B40, TSTK-C40 PG, Перфорированный кабельный Лоток	400 мм	1	метр
60	3000	4,773					
100	3000	4,900					
1,2	метр	50				3000	4,980
		60				3000	5,727
		100				3000	5,880
1,5	метр	50				3000	6,250
		60				3000	7,188
		100				3000	7,350
2	метр	50				3000	8,300
		60				3000	9,545
		100				3000	9,800
11	TSKT-A50 PG, TSTK-B50, TSTK-C50 PG, Перфорированный кабельный Лоток	500 мм	1	метр	50	3000	4,950
					60	3000	5,445
					100	3000	5,700
			1,2	метр	50	3000	5,940
					60	3000	6,534
					100	3000	6,840
			1,5	метр	50	3000	7,450
					60	3000	8,195
					100	3000	8,500
			2	метр	50	3000	9,900
					60	3000	10,890
					100	3000	11,400
12	TSKT-A60 PG, TSTK-B60, TSTK-C60 PG, Перфорированный кабельный Лоток	600 мм	1	метр	50	3000	5,700
					60	3000	6,270
					100	3000	6,840
			1,2	метр	50	3000	6,840
					60	3000	7,524
					100	3000	8,208
			1,5	метр	50	3000	8,550
					60	3000	9,405
					100	3000	10,260
			2	метр	50	3000	12,408
					60	3000	13,401
					100	3000	13,773

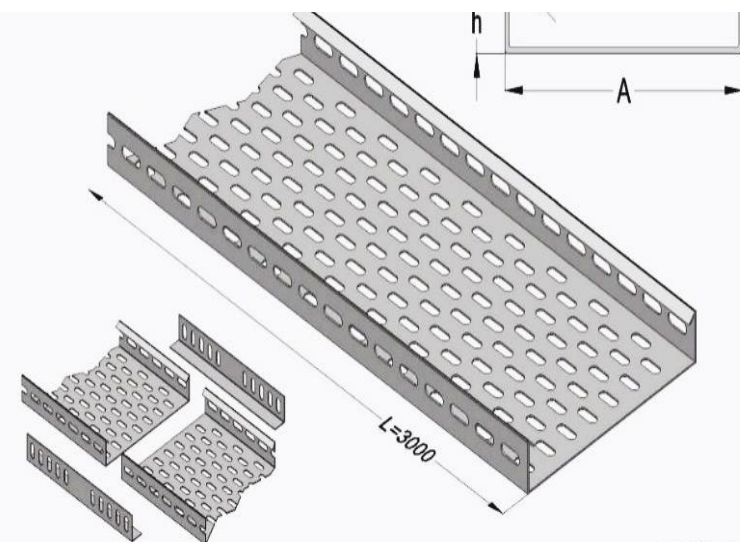

TSKT-A/5

Аксессуары: Горизонтальный угол 90° (PG)							
	Наименование	А:	е:	Ед.	h:		Вес
13	TSD-A5/5, TSD-B5 PG, Горизонтальный угол 90°	50 мм	1	шт.	50		0,660
					60		0,792
			1,2	шт.	50		0,792
					60		0,950
			1,5	шт.	50		0,990
					60		1,426
14	TSD-A10/5, TSD-B10, TSD-C10 PG, Горизонтальный угол 90°	100 мм	1	шт.	50		0,767
					60		0,900
					100		1,100
			1,2	шт.	50		0,920
					60		1,080
					100		1,320
			1,5	шт.	50		1,150
					60		1,350
					100		1,650
15	TSD-A20/5, TSD-B20, TSD-C20 PG, Горизонтальный угол 90°	200	1	шт.	50		1,320
					60		1,467
					100		1,600
			1,2	шт.	50		1,584
					60		1,760
					100		1,920
			1,5	шт.	50		1,980
					60		2,200
					100		2,400
16	TSD-A30/5, TSD-B30, TSD-C30 PG, Горизонтальный угол 90°	300	1,2	шт.	50		2,310
					60		2,610
					100		2,820
			1,5	шт.	50		2,888
					60		3,263
					100		3,525
			2	шт.	50		3,850
					60		4,350
					100		4,700
17	TSD-A40/5, TSD-B40, TSD-C40 PG, Горизонтальный угол 90°	400	1,2	шт.	50		3,480
					60		4,380
					100		5,280
			1,5	шт.	50		4,350
					60		5,475

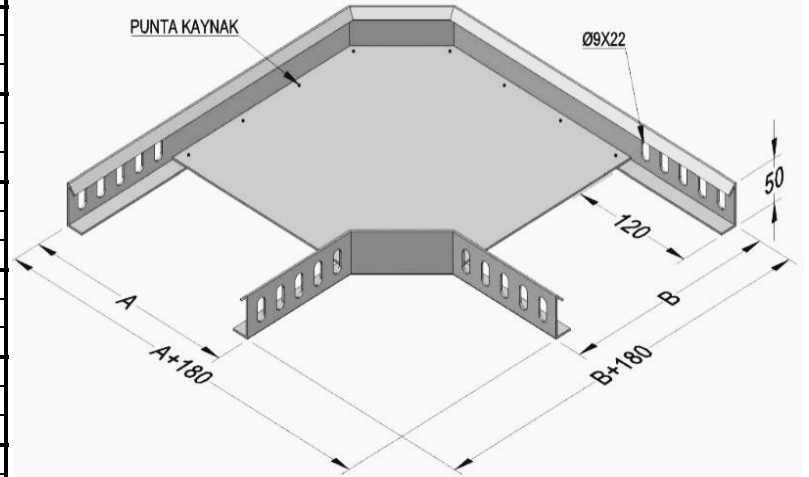

Горизонтальный угол 90°				100	6,600	TSD-A/5 DL
18	TSD-A50/5, TSD-B50, TSD-C50 PG, Горизонтальный угол 90°	500	2	шт.	50	5,800
					60	7,300
					100	8,800
			1,2	шт.	50	4,770
					60	5,460
					100	6,120
			1,5	шт.	50	5,963
					60	6,825
					100	7,650
			2	шт.	50	7,950
					60	9,100
					100	10,200
19	TSD-A60/5, TSD-B60, TSD-C60 PG, Горизонтальный угол 90°	600	1,2	шт.	50	6,450
					60	6,840
					100	7,140
			1,5	шт.	50	8,063
					60	8,550
					100	8,925
			2	шт.	50	10,750
					60	11,400
					100	11,900

Аксессуары: Т-Образный элемент (PG)								
Наименование	А:	е:	Ед.	h:	Вес			
20 TST-A5/5 PG, TST-B5 PG, Т-Образный элемент	50 мм	1	шт.	50	0,710			
				60	0,852			
		1,2	шт.	50	0,852			
				60	1,022			
		1,5	шт.	50	1,065			
				60	1,534			
		21 TST-A10/5, TST-B10, TST-C10 PG, Т-Образный элемент	100 мм	1	шт.	50	0,907	
						60	1,088	
100	1,447							
1,2	шт.			50	1,088			
				60	1,306			
				100	1,736			
1,5	шт.			50	1,360			
				60	1,632			
				100	2,170			
						50	1,300	

22	TST-A20/5, TST-B20, TST-C20 PG, T- Образный элемент	200 мм	1	шт.	60	1,560
					100	2,067
					50	1,560
			1,2	шт.	60	1,872
					100	2,480
					50	1,950
			1,5	шт.	60	2,340
					100	3,100
					50	2,268
23	TST-A30/5, TST-B30, TST-C30 PG, T- Образный элемент	300 мм	1,2	шт.	60	2,722
					100	3,270
					50	2,835
			1,5	шт.	60	3,402
					100	4,088
					50	3,780
			2	шт.	60	4,536
					100	5,450
					50	3,210
24	TST-A40/5, TST-B40, TST-C40 PG, T- Образный элемент	400 мм	1,2	шт.	60	3,852
					100	4,320
					50	4,013
			1,5	шт.	60	4,815
					100	5,400
					50	5,350
			2	шт.	60	6,420
					100	7,200
					50	4,290
25	TST-A50/5, TST-B50, TST-C50 PG, T- Образный элемент	500 мм	1,2	шт.	60	4,719
					100	5,340
					50	5,363
			1,5	шт.	60	5,899
					100	6,675
					50	7,150
			2	шт.	60	7,865
					100	8,900
					50	5,610
26	TST-A60/5, TST-B60, TST-C60 PG, T- Образный элемент	600 мм	1,2	шт.	60	6,171
					100	6,750
					50	7,013
			1,5	шт.	60	7,714
					100	8,438
					50	9,350
			2	шт.	60	10,285
					100	11,250

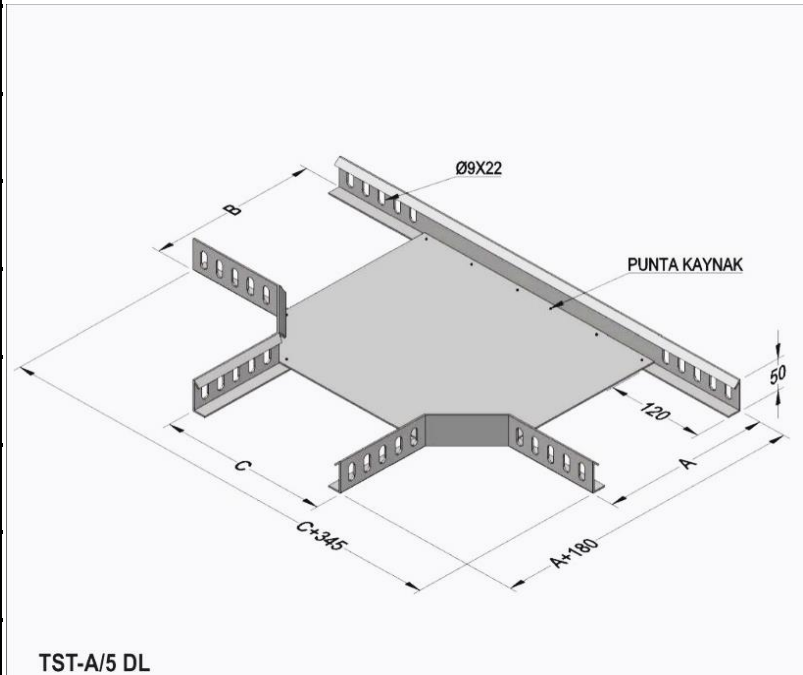

Аксессуары: Кресто-образный элемент (PG)							
	Наименование	A:	e:	Ед.	h:		Вес
27	TSDB-A5/5, TSDB-B5 PG, Кресто-образный элемент	50 мм	1	шт.	50		0,900
					60		1,080
			1,2	шт.	50		1,080
					60		1,296
			1,5	шт.	50		1,350
					60		1,944
28	TSDB-A10/5, TSDB-B10, TSDB-C10 PG, Кресто-образный элемент	100 мм	1	шт.	50		1,000
					60		1,167
					100		1,333
			1,2	шт.	50		1,200
					60		1,400
					100		1,600
			1,5	шт.	50		1,500
					60		1,750
					100		2,000
29	TSDB-A20/5, TSDB-B20, TSDB-C20 PG, Кресто-образный элемент	200 мм	1	шт.	50		1,533
					60		1,840
					100		2,267
			1,2	шт.	50		1,840
					60		2,208
					100		2,720
			1,5	шт.	50		2,300
					60		2,760
					100		3,400
30	TSDB-A30/5, TSDB-B30, TSDB-C30 PG, Кресто-образный элемент	300 мм	1,2	шт.	50		2,610
					60		3,132
					100		3,390
			1,5	шт.	50		3,263
					60		3,915
					100		4,238
			2	шт.	50		4,350
					60		5,220
					100		5,650
31	TSDB-A40/5, TSDB-B40, TSDB-C40 PG, Кресто-образный элемент	400 мм	1,2	шт.	50		4,170
					60		4,320
					100		4,380
			1,5	шт.	50		5,213
					60		5,400

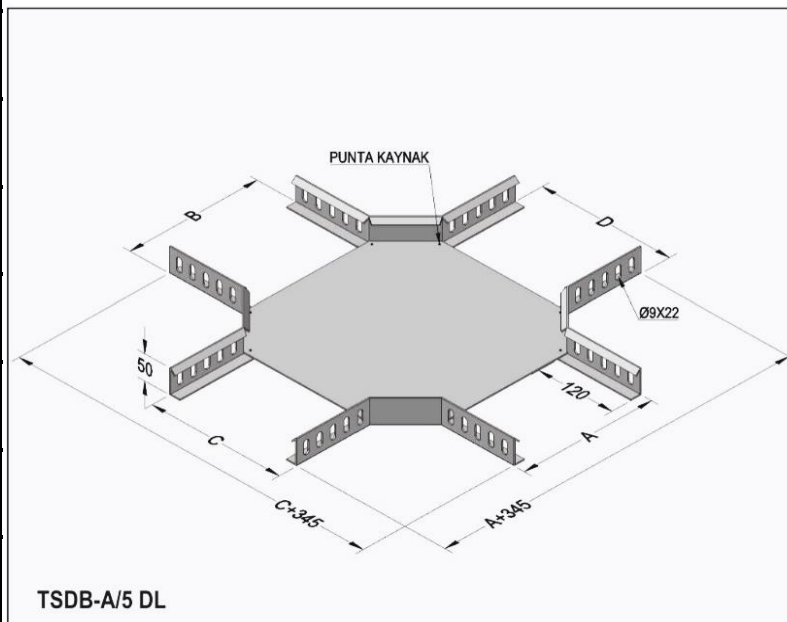

TSDB-A/5 DL

кресто-образный элемент				100	5,475			
32	TSDB-A50/5, TSDB-B50, TSDB-C50 PG, Кресто-образный элемент	500 мм	2	шт.	50	6,950		
				шт.	60	7,200		
				шт.	100	7,300		
			1,2	шт.	50	4,800		
				шт.	60	5,040		
				шт.	100	5,280		
		1,5	шт.	50	6,000			
			шт.	60	6,300			
			шт.	100	6,600			
		33	TSDB-A60/5, TSDB-B60, TSDB-C60 PG, Кресто-образный элемент	600 мм	1,2	шт.	50	6,000
						шт.	60	6,300
						шт.	100	6,600
1,5	шт.				50	7,500		
	шт.				60	7,875		
	шт.				100	8,250		
2	шт.	50	10,000					
	шт.	60	10,500					
	шт.	100	11,000					

Крепёжный элемент: Соединительный элемент лотка (PG)

Наименование		A:	e:	Ед.	h:	L: (мм)	Вес
34	TS1-3, TS1-4, TS1-5 PG, Соединительный элемент лотка	23 мм	1,5	шт.	50	250	0,180
					60	250	0,308
					100	250	0,420
			2	шт.	50	250	0,240
					60	250	0,410
					100	250	0,560

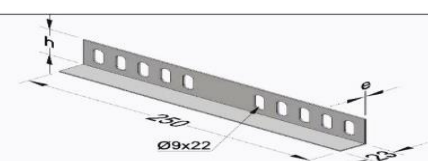

TS1 DL
TS2 DL

Аксессуары: Горизонтальный угол 90° радиус 300° (PG)

Наименование		A:	e:	Ед.	h:	Вес
35	TSD-A5/5 300R, TSD-B5 300R PG, Горизонтальный угол 90° радиус 300°	50 мм	1	шт.	50	0,940
					60	1,250
			1,2	шт.	50	1,128
					60	1,500
					50	1,410

			1,5	шт.	60	1,875
36	TSD-A10/5 300R, TSD-B10 300R, TSD-C10 300R PG, Горизонтальный угол 90° радиус 300°	100 мм	1	шт.	50	1,100
					60	1,160
					100	1,460
			1,2	шт.	50	1,320
					60	1,392
					100	1,752
			1,5	шт.	50	1,650
					60	1,740
					100	2,190
37	TSD-A20/5 300R, TSD-B20 300R, TSD-C20 300R PG, Горизонтальный угол 90° радиус 300°	200 мм	1	шт.	50	1,690
					60	1,770
					100	2,140
			1,2	шт.	50	2,028
					60	2,124
					100	2,568
			1,5	шт.	50	2,535
					60	2,655
					100	3,210
38	TSD-A30/5 300R, TSD-B30 300R, TSD-C30 300R PG, Горизонтальный угол 90° радиус 300°	300 мм	1,2	шт.	50	2,910
					60	2,950
					100	3,750
			1,5	шт.	50	3,638
					60	3,688
					100	4,688
			2	шт.	50	4,838
					60	4,904
					100	6,234
39	TSD-A40/5 300R, TSD-B40 300R, TSD-C40 300R PG, Горизонтальный угол 90° радиус 300°	400 мм	1,2	шт.	50	3,900
					60	4,000
					100	4,480
			1,5	шт.	50	4,875
					60	5,000
					100	5,600
			2	шт.	50	6,484
					60	6,650
					100	7,448
40	TSD-A50/5 300R, TSD-B50 300R, TSD-C50 300R PG, Горизонтальный угол 90° радиус 300°	500 мм	1,2	шт.	50	5,200
					60	5,300
					100	11,700
			1,5	шт.	50	6,500
					60	6,625
					100	14,625

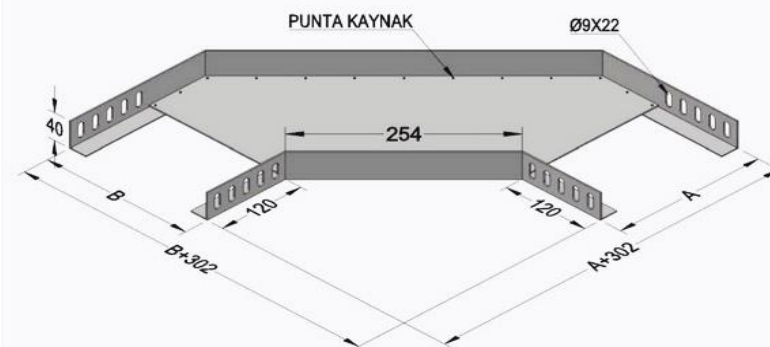

TSD 300R DL

			2	шт.	50	8,645		
					60	8,811		
					100	19,451		
41	TSD-A60/5 300R, TSD-B60 300R, TSD-C60 300R PG, Горизонтальный угол 90° радиус 300°	600 мм	1,2	шт.	50	6,650		
					60	6,700		
					100	13,800		
					1,5	шт.	50	8,313
				60			8,375	
				100			17,250	
				2	шт.	50	11,056	
						60	11,139	
						100	22,943	

Аксессуары: Т-образный элемент радиус 300° (PG)						
Наименование	A:	e:	Ед.	h:	Вес	
TST-A5/5 PG, TST-B5 PG, Т-образный элемент, радиус 300°	50 мм	1	шт.	50	1,620	
				60	1,720	
			1,2	шт.	50	1,944
					60	2,064
			1,5	шт.	50	2,430
					60	2,580
TST-A10/5, TST-B10, TST-C10 PG, Т-образный элемент, радиус 300°	100 мм	1	шт.	50	1,860	
				60	2,000	
				100	2,450	
			1,2	шт.	50	2,232
					60	2,400
					100	2,940
			1,5	шт.	50	2,790
					60	3,000
					100	3,675
TST-A20/5, TST-B20, TST-C20 PG, Т-образный элемент, радиус 300°	200 мм	1	шт.	50	2,800	
				60	2,970	
				100	3,550	
			1,2	шт.	50	3,360
					60	3,564
					100	4,260
			1,5	шт.	50	4,200
					60	4,455

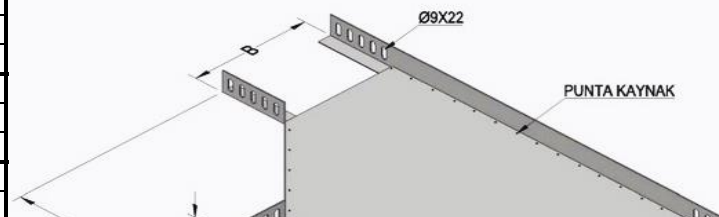

TST-A30/5, TST-B30, TST-C30 PG, T-Образный элемент, радиус 300°	300 мм	1,2	шт.	100	5,325		
				50	4,550		
				60	4,700		
		1,5	шт.	50	5,688		
				60	5,875		
				100	6,750		
		2	шт.	50	7,564		
				60	7,814		
				100	8,978		
		TST-A40/5, TST-B40, TST-C40 PG, T-Образный элемент, радиус 300°	400 мм	1,2	шт.	50	6,000
						60	6,200
						100	7,000
1,5	шт.			50	7,500		
				60	7,750		
				100	8,750		
2	шт.			50	9,975		
				60	10,308		
				100	11,638		
TST-A50/5, TST-B50, TST-C50 PG, T-Образный элемент, радиус 300°	500 мм			1,2	шт.	50	7,470
						60	7,500
						100	8,400
		1,5	шт.	50	9,338		
				60	9,375		
				100	10,500		
		2	шт.	50	12,419		
				60	12,469		
				100	13,965		
		TST-A60/5, TST-B60, TST-C60 PG, T-Образный элемент, радиус 300°	600 мм	1,2	шт.	50	9,270
						60	9,330
						100	10,200
1,5	шт.			50	11,588		
				60	11,663		
				100	12,750		
2	шт.			50	15,411		
				60	15,511		
				100	16,958		

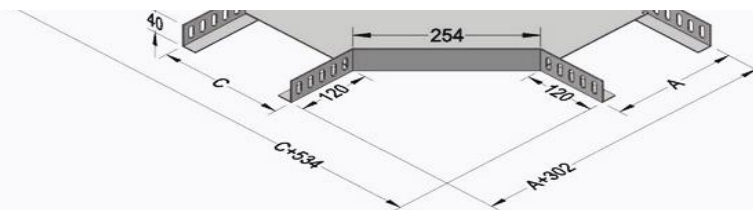

TST 300R DL

Аксессуары: Внутренний (внешний) вертикальный угол. (PG)

Наименование

A:

e:

Ед.

h:

Вес

50

1,600

TSIB-A5/5, TSIB-B5 PG, Внутренний (внешний) вертикальный угол	50 мм	1	шт.	60	1,800
				50	1,920
		1,2	шт.	60	2,160
				50	2,400
		1,5	шт.	60	2,700
				50	
TSIB-A10/5, TSIB-B10, TSIB-C10 PG, Внутренний (внешний) вертикальный угол	100 мм	1	шт.	50	2,300
				60	2,400
				100	2,500
		1,2	шт.	50	2,760
				60	2,880
				100	3,000
		1,5	шт.	50	3,450
				60	3,600
				100	3,750
TSIB-A20/5, TSIB-B20, TSIB-C20 PG, Внутренний (внешний) вертикальный угол	200 мм	1	шт.	50	2,800
				60	2,900
				100	3,000
		1,2	шт.	50	3,360
				60	3,480
				100	3,600
		1,5	шт.	50	4,200
				60	4,350
				100	4,500
TSIB-A30/5, TSIB-B30, TSIB-C30 PG, Внутренний (внешний) вертикальный угол	300 мм	1,2	шт.	50	4,410
				60	4,500
				100	4,700
		1,5	шт.	50	5,513
				60	5,625
				100	5,875
		2	шт.	50	7,332
				60	7,481
				100	7,814
TSIB-A40/5, TSIB-B40, TSIB-C40 PG, Внутренний (внешний) вертикальный угол	400 мм	1,2	шт.	50	4,950
				60	5,100
				100	5,300
		1,5	шт.	50	6,188
				60	6,375
				100	6,625
		2	шт.	50	8,229
				60	8,479
				100	8,811



TSIB DL

TSIB-A50/5, TSIB-B50, TSIB-C50 PG, Внутренний (внешний) вертикальный угол	500 мм	1,2	шт.	50	5,700
				60	5,900
				100	6,100
		1,5	шт.	50	7,125
				60	7,375
				100	7,625
		2	шт.	50	9,476
				60	9,809
				100	10,141
TSIB-A60/5, TSIB-B60, TSIB-C60 PG, Внутренний (внешний) вертикальный угол	600 мм	1,2	шт.	50	6,700
				60	6,900
				100	7,100
		1,5	шт.	50	8,375
				60	8,625
				100	8,875
		2	шт.	50	11,139
				60	11,471
				100	11,804

Аксессуары: Горизонтальный угол 45° (PG)						
Наименование	A:	e:	Ед.	h:	Вес	
TSD-A5-45/5, TSD-B5-45 PG, Горизонтальный угол 45°	50 мм	1	шт.	50	0,470	
				60	0,700	
		1,2	шт.	50	0,564	
				60	0,840	
1,5	шт.	50	0,705			
		60	1,050			
TSD-A10-45/5, TSD-B10-45, TSD-C10-45 PG, Горизонтальный угол 45°	100 мм	1	шт.	50	0,650	
				60	1,200	
				100	1,300	
		1,2	шт.	50	0,780	
				60	1,440	
				100	1,560	
		1,5	шт.	50	0,975	
				60	1,800	
				100	1,950	
1	шт.	50	1,260			
		60	1,400			



TSD-A20-45/5, TSD-B20-45, TSD-C20-45 PG, Горизонтальный угол 45°	200 мм	1,2	шт.	100	1,750		
				50	1,512		
				60	1,680		
		1,5	шт.	50	1,890		
				60	2,100		
				100	2,625		
		TSD-A30-45/5, TSD-B30-45, TSD-C30-45 PG, Горизонтальный угол 45°	300 мм	1,2	шт.	50	1,920
						60	2,000
						100	2,600
1,5	шт.			50	2,400		
				60	2,500		
				100	3,250		
2	шт.			50	3,192		
				60	3,325		
				100	4,323		
TSD-A40-45/5, TSD-B40-45, TSD-C40-45 PG, Горизонтальный угол 45°	400 мм	1,2	шт.	50	2,050		
				60	2,400		
				100	3,240		
		1,5	шт.	50	2,563		
				60	3,000		
				100	4,050		
		2	шт.	50	3,408		
				60	3,990		
				100	5,387		
TSD-A50-45/5, TSD-B50-45, TSD-C50-45 PG, Горизонтальный угол 45°	500 мм	1,2	шт.	50	3,350		
				60	3,500		
				100	3,900		
		1,5	шт.	50	4,188		
				60	4,375		
				100	4,875		
		2	шт.	50	5,569		
				60	5,819		
				100	6,484		
TSD-A60-45/5, TSD-B60-45, TSD-C60-45 PG, Горизонтальный угол 45°	600 мм	1,2	шт.	50	4,110		
				60	4,300		
				100	4,740		
		1,5	шт.	50	5,138		
				60	5,375		
				100	5,925		
		2	шт.	50	6,833		
				60	7,149		
				100	7,880		

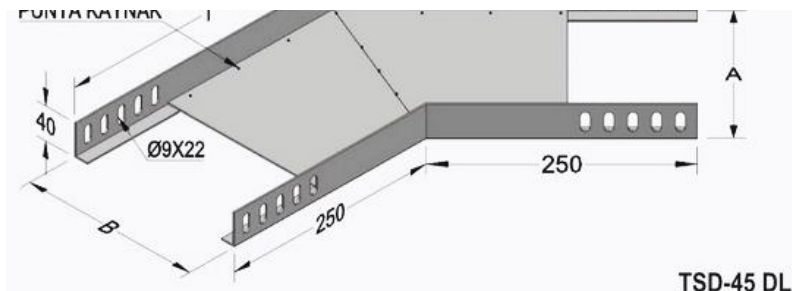

TSD-45 DL

Кабельный лоток с выдвигающейся крышкой (PG)								
Наименование	A:	e:\t:	Ед.	h:	L: (мм)	Вес		
TSGKT-10, TSGKT-A10, TSGKT-B10 PG, Перфорированный кабельный лоток с крышкой	100 мм	1\0,8	метр	60	3000	2,267		
				70	3000	2,600		
				100	3000	2,800		
		1,5\1	метр	60	3000	3,400		
				70	3000	3,900		
				100	3000	4,200		
		2\1	метр	60	3000	4,533		
				70	3000	5,200		
				100	3000	5,600		
TSGKT-20, TSGKT-A20, TSGKT-B20 PG, Перфорированный кабельный лоток с крышкой	200 мм	1\0,8	метр	60	3000	3,780		
				70	3000	3,900		
				100	3000	4,267		
		1,5\1	метр	60	3000	5,670		
				70	3000	5,850		
				100	3000	6,400		
		2\1	метр	60	3000	7,560		
				70	3000	7,800		
				100	3000	8,533		
TSGKT-30, TSGKT-A30, TSGKT-B30 PG, Перфорированный кабельный лоток с крышкой	300 мм	1\0,8	метр	60	3000	5,260		
				70	3000	5,600		
				100	3000	6,075		
		1,5\1	метр	60	3000	7,890		
				70	3000	8,400		
				100	3000	9,113		
		2\1	метр	60	3000	10,520		
				70	3000	11,200		
				100	3000	12,150		
TSGKT-40, TSGKT-A40, TSGKT-B40 PG, Перфорированный кабельный лоток с крышкой	400 мм	1\0,8	метр	60	3000	6,500		
				70	3000	6,750		
				100	3000	7,200		
		1,5\1	метр	60	3000	9,750		
				70	3000	10,125		
				100	3000	10,800		
		2\1	метр	60	3000	13,000		
				70	3000	13,500		
				100	3000	14,400		
TSGKT-50, TSGKT-A50, TSGKT-B50 PG,				60	3000	11,490		

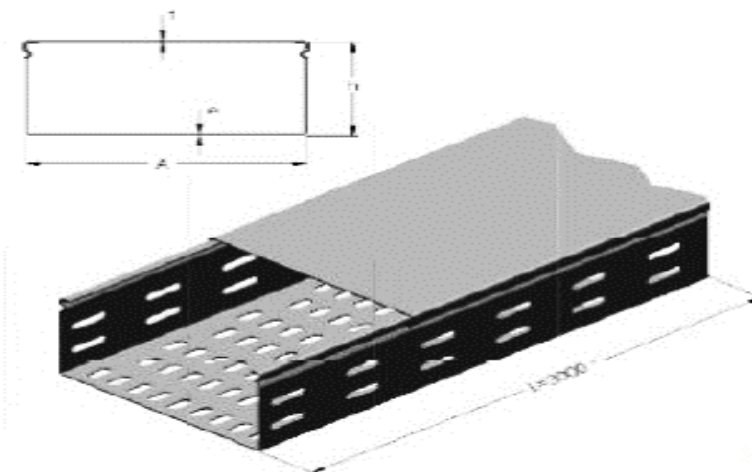

Перфорированный кабельный лоток с крышкой	500 мм	1,5\1	метр	70	3000	11,813
				100	3000	12,525
		2\1,5	метр	60	3000	15,320
				70	3000	15,750
				100	3000	16,700
TSGKT-60, TSGKT-A60, TSGKT-B60 PG, Перфорированный кабельный лоток с крышкой	600 мм	1,5\1	метр	60	3000	13,350
				70	3000	13,500
		2\1,5	метр	60	3000	17,800
				70	3000	18,000

Аксессуары: Вертикальный Т-образный элемент (PG)						
Наименование	А:	е:	Ед.	h:		Вес
TSDTD-5/5, TSDTD-B5 PG, Вертикальный Т-образный элемент	50 мм	1	шт.	50		0,800
				60		0,900
		1,2	шт.	50		0,960
				60		1,080
1,5	шт.	50		1,200		
		60		1,350		
TSDTD-10/5, TSDTD-B10, TSDTD-C10 PG, Вертикальный Т-образный элемент	100 мм	1	шт.	50		1,033
				60		1,200
				100		1,633
		1,2	шт.	50		1,240
				60		1,440
				100		1,960
		1,5	шт.	50		1,550
				60		1,800
				100		2,450
TSDTD-20/5, TSDTD-B20, TSDTD-C20 PG, Вертикальный Т-образный	200 мм	1	шт.	50		1,867
				60		2,000
				100		2,520
		1,2	шт.	50		2,240
				60		2,400



элемент				100		3,024
				50		2,800
TSDTD-30/5, TSDTD-B30, TSDTD-C30 PG, Вертикальный Т- образный элемент	300 мм	1,5	шт.	60		3,000
				100		3,780
				50		3,420
		1,2	шт.	60		3,600
				100		4,320
				50		4,275
		1,5	шт.	60		4,500
				100		5,400
				50		5,700
2	шт.	60		6,000		
		100		7,200		
		50		4,890		
TSDTD-40/5, TSDTD-B40, TSDTD-C40 PG, Вертикальный Т- образный элемент	400 мм	1,2	шт.	60		5,016
				100		5,790
				50		6,113
		1,5	шт.	60		6,270
				100		7,238
				50		8,150
		2	шт.	60		8,360
				100		9,650
				50		6,540
TSDTD-50/5, TSDTD-B50, TSDTD-C50 PG, Вертикальный Т- образный элемент	500 мм	1,2	шт.	60		6,630
				100		7,488
				50		8,175
		1,5	шт.	60		8,288
				100		9,360
				50		10,900
		2	шт.	60		11,050
				100		12,480
				50		8,400
TSDTD-60/5, TSDTD-B60, TSDTD-C60 PG, Вертикальный Т- образный элемент	600 мм	1,2	шт.	60		8,448
				100		9,396
				50		10,500
		1,5	шт.	60		10,560
				100		11,745
				50		14,000
		2	шт.	60		14,080
				100		15,660
				50		

